



Solid State Devices, Inc.

14701 Firestone Blvd * La Mirada, Ca 90638
 Phone: (562) 404-4474 * Fax: (562) 404-1773
 ssdi@ssdi-power.com * www.ssdi-power.com

SFT5152 and SFT5154

DESIGNER'S DATA SHEET

Part Number / Ordering Information ^{1/}

SFT5152
 SFT5154

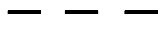

Screening ^{2/}

___ = Not Screened
 TX = TX Level
 TXV = TXV Level
 S = S Level

Lead Bend Options

___ = Straight
 UB = Up Bend
 DB = Down Bend

Package ^{3/}

J = TO-257
 /5 = TO-5
 G = Cerpack
 S.5 = SMD.5

10 AMP POWER TRANSISTORS SILICON NPN

100 VOLTS
 10 WATTS

Features:

- Radiation Tolerant
- Fast Switching, 500 nsec max t_{on}
- High Frequency, Typical $f_t = 85$ MHz
- BVCEO 80 Volts Min
- High Linear Gain, Low Saturation Voltage
- 200°C Operating Temperature
- Designed for Complementary Use with SFT5151 and SFT5153
- Replacement for 2N5152 and 2N5154
- TX, TXV, S-Level Screening Available^{2/} - Consult Factory

Maximum Ratings	Symbol	Value	Units
Collector – Emitter Voltage	V_{CEO}	80	Volts
Collector – Base Voltage	V_{CBO}	100	Volts
Emitter – Base Voltage	V_{EBO}	5.5	Volts
Collector Current	I_C	10	Amps
Base Current	I_B	2.5	Amps
Total Device Dissipation @ TC = 50°C Derate above 50°C	P_D	10 66.6	W mW/°C
Operating & Storage Temperature	Top & Tstg	-65 to +200	°C
Maximum Thermal Resistance Junction to Case	TO-257 (J) TO-5 (/5) Cerpack (G) SMD.5 (S.5)	5 10 3 3	°C/W

NOTES:

- * Pulse Test: Pulse Width = 300µsec, Duty Cycle = 2%
- ^{1/} For ordering information, price, operating curves, and availability - contact factory.
- ^{2/} Screening based on MIL-PRF-19500. Screening flows available on request.
- ^{3/} For package outlines - contact factory.
- ^{4/} Unless otherwise specified, all electrical characteristics @25°C.

Available parts:

SFT5152J, SFT5152/5, SFT5152G, SFT5152S.5
 SFT5154J, SFT5154/5, SFT5154G, SFT5154S.5

TO-257 (J)

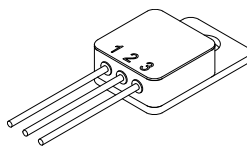

TO-5 (/5)

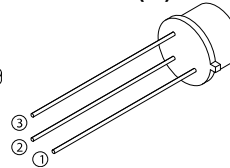

Cerpack (G)

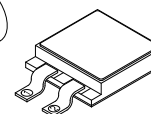

SMD.5 (S.5)

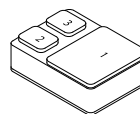

NOTE: All specifications are subject to change without notification.
 SCD's for these devices should be reviewed by SSDI prior to release.

DATA SHEET #: TR0110B

DOC



Solid State Devices, Inc.

14701 Firestone Blvd * La Mirada, Ca 90638
 Phone: (562) 404-4474 * Fax: (562) 404-1773
 ssdi@ssdi-power.com * www.ssdi-power.com

SFT5152 and SFT5154

Electrical Characteristic ^{4/}		Symbol	Min	Max	Units	
Collector – Emitter Breakdown Voltage*		$I_C = 100\text{mA}$	BV_{CEO}	80	—	Volts
Collector – Base Breakdown Voltage		$I_C = 200\mu\text{A}$	BV_{CBO}	100	—	Volts
Emitter – Base Breakdown Voltage		$I_E = 200\mu\text{A}$	BV_{EBO}	5.5	—	Volts
Collector – Cutoff Current		$V_{CE} = 40\text{V}$	I_{CEO}	—	50	μA
Collector – Cutoff Current		$V_{CE} = 60\text{V}, V_{BE} = 2\text{V}, T_C = 150^\circ\text{C}$	I_{CEV}	—	25	μA
Collector – Cutoff Current		$V_{CE} = 60\text{V}$ $V_{CE} = 100\text{V}$	I_{CES}	—	1.0 1.0	μA mA
Emitter – Cutoff Current		$V_{EB} = 4\text{V}$ $V_{EB} = 5.5\text{V}$	I_{EBO}	—	1.0 1.0	μA mA
DC Current Gain *	SFT5152	$V_{CE} = 5\text{V}, I_C = 50\text{mA}$ $V_{CE} = 5\text{V}, I_C = 2.5\text{A}$ $V_{CE} = 5\text{V}, I_C = 2.5\text{A}, T_A = -55^\circ\text{C}$ $V_{CE} = 5\text{V}, I_C = 5\text{A}$	h_{FE}	20	—	—
	SFT5154	$V_{CE} = 5\text{V}, I_C = 50\text{mA}$ $V_{CE} = 5\text{V}, I_C = 2.5\text{A}$ $V_{CE} = 5\text{V}, I_C = 2.5\text{A}, T_A = -55^\circ\text{C}$ $V_{CE} = 5\text{V}, I_C = 5\text{A}$		30 15 20 50 70 25 40	250 — — — 250 — —	
Collector – Emitter Saturation Voltage *		$I_C = 2.5\text{A}, I_B = 250\text{mA}$ $I_C = 5.0\text{A}, I_B = 500\text{mA}$	$V_{CE(Sat)}$	— —	0.75 1.5	Volts
Base – Emitter Saturation Voltage *		$I_C = 2.5\text{A}, I_B = 250\text{mA}$ $I_C = 5.0\text{A}, I_B = 500\text{mA}$	$V_{BE(Sat)}$	— —	1.45 2.2	Volts
Common Emitter small signal gain		$V_{CE} = 5\text{V}, I_C = 0.1\text{A}, f = 1\text{kHz}$	h_{fe}	20 50	—	—
Current Gain Bandwidth Product		$V_{CE} = 5\text{V}, I_C = 0.5\text{A}, f = 10\text{MHz}$	f_T	60 70	—	MHz
Output Capacitance		$V_{CB} = 10\text{V}, I_E = 0\text{A}, f = 1\text{MHz}$	C_{ob}	—	250	pF
Base – Emitter Voltage*		$V_{CE} = 5\text{V}, I_C = 2.5\text{A}$	$V_{BE(ON)}$	—	1.45	Volts
Safe Operating Area		$V_{CE} = 5\text{V}, I_C = 2.0\text{A}, 1\text{ sec}$ $V_{CE} = 32\text{V}, I_C = 310\text{ mA}, 1\text{ sec}$ $V_{CE} = 80\text{V}, I_C = 12.5\text{mA}, 1\text{ sec}$	SOA_1 SOA_2 SOA_3	— — —	— — —	— — —
ON Time	$V_{CC} = 30\text{V}, V_{EB(off)} = 3.7\text{V}$ $I_C = 5\text{A}$		t_{ON}	—	500	nsec
OFF Time			t_{OFF}	—	1500	
Storage Time	$V_{EB(off)} = 3.7\text{V}, I_{B1} = I_{B2} = 0.5\text{A},$ $R_L = 6\text{ Ohms}$		t_s	—	1.4	μsec
Fall Time			t_f	—	0.5	

NOTE: All specifications are subject to change without notification.
 SCD's for these devices should be reviewed by SSDI prior to release.

DATA SHEET #: TR0110B

DOC



Solid State Devices, Inc.

14701 Firestone Blvd * La Mirada, Ca 90638
 Phone: (562) 404-4474 * Fax: (562) 404-1773
 ssdi@ssdi-power.com * www.ssdi-power.com

SFT5152 and SFT5154

TO-257 (J)

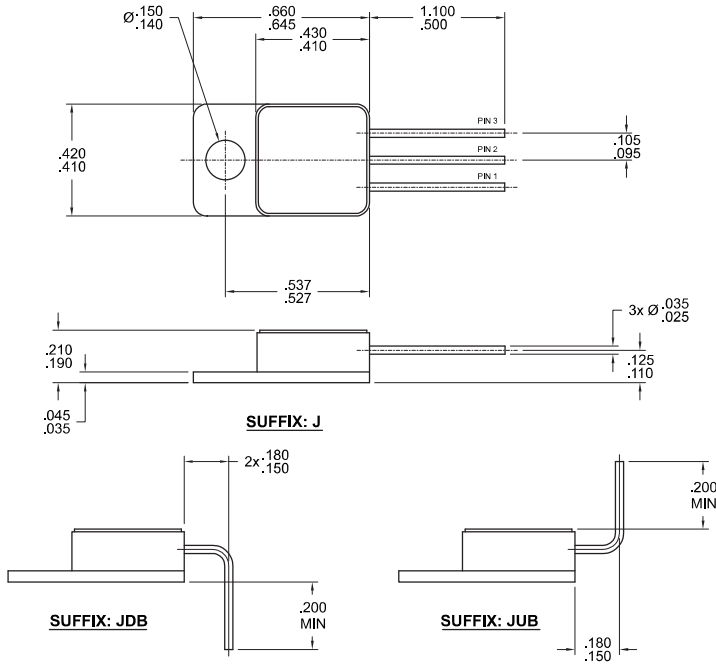

SUFFIX: J

SUFFIX: JDB

SUFFIX: JUB

PIN ASSIGNMENT

Package	Pin 1	Pin 2	Pin 3
TO-257	Collector	Emitter	Base

TO-5 (I5)

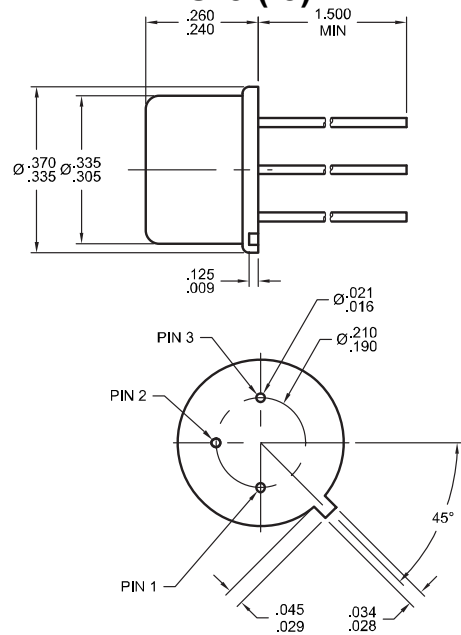

PIN ASSIGNMENT

Package	Pin 1	Pin 2	Pin 3 (Case)
TO-5	Emitter	Base	Collector

Cerpack (G)

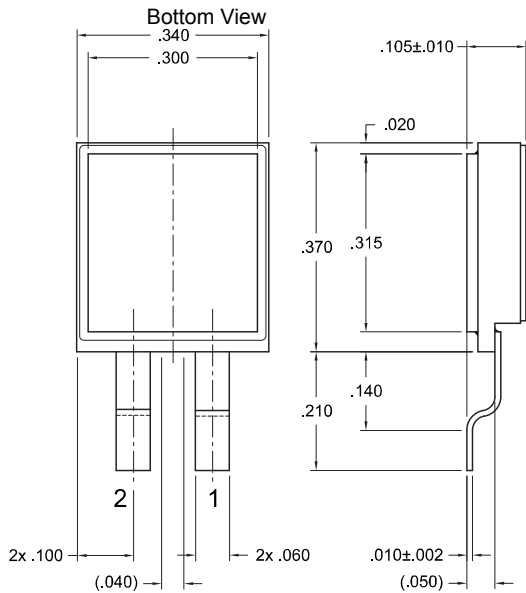

PIN ASSIGNMENT

Package	Pin 1	Pin 2	Tab
Cerpack	Emitter	Base	Collector

SMD.5 (S.5)

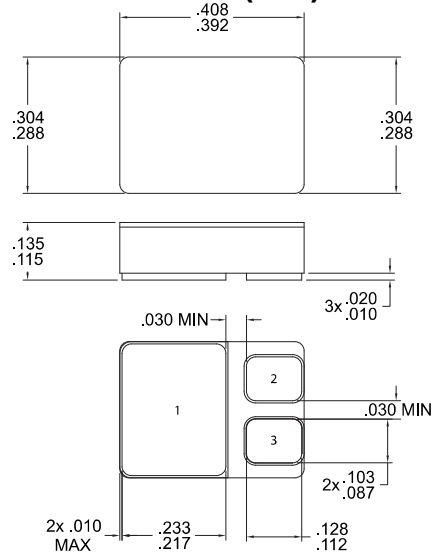

PIN ASSIGNMENT

Package	Pin 1	Pin 2	Pin 3
SMD.5	Collector	Emitter	Base

NOTE: All specifications are subject to change without notification. SCD's for these devices should be reviewed by SSDI prior to release.

DATA SHEET #: TR0110B

DOC